

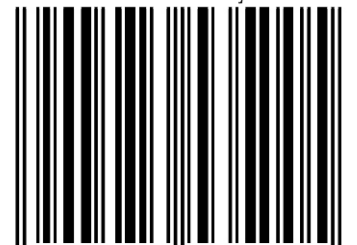

# **ASSEMBLY INSTRUCTIONS /MONTAGEANLEITUNGEN**

Gacek S.C Bujak



5 904473 535005 >

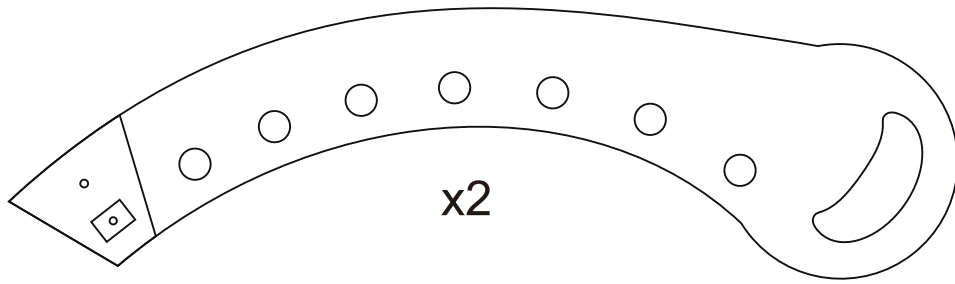

x2

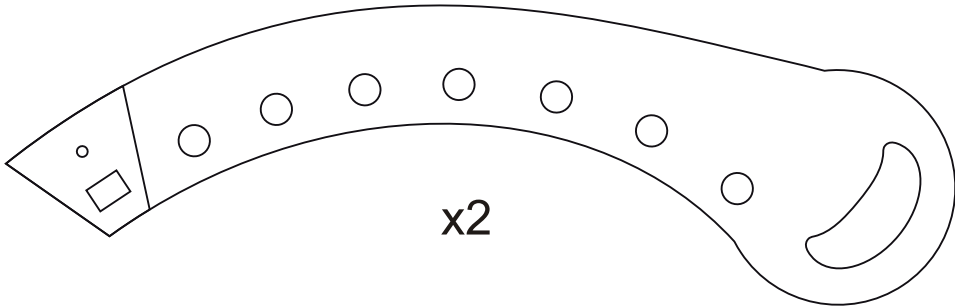

x2



x12

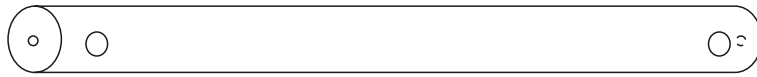

x2

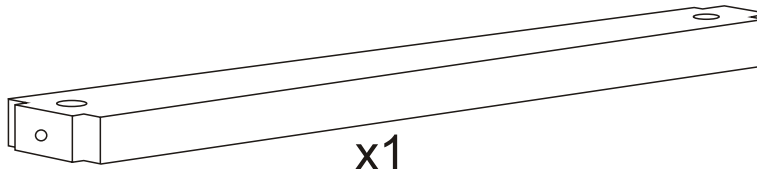

x1



x 2 SZT M6 X 16 MM



x 2 SZT M6 X 10 MM



x 24 SZT



x 6 SZT M6 x 10 x 13 MM



x 6 SZT M6 X 50 MM



x 1SZT 4MM

1.

M6 X 10 MM

M6 X 16 MM

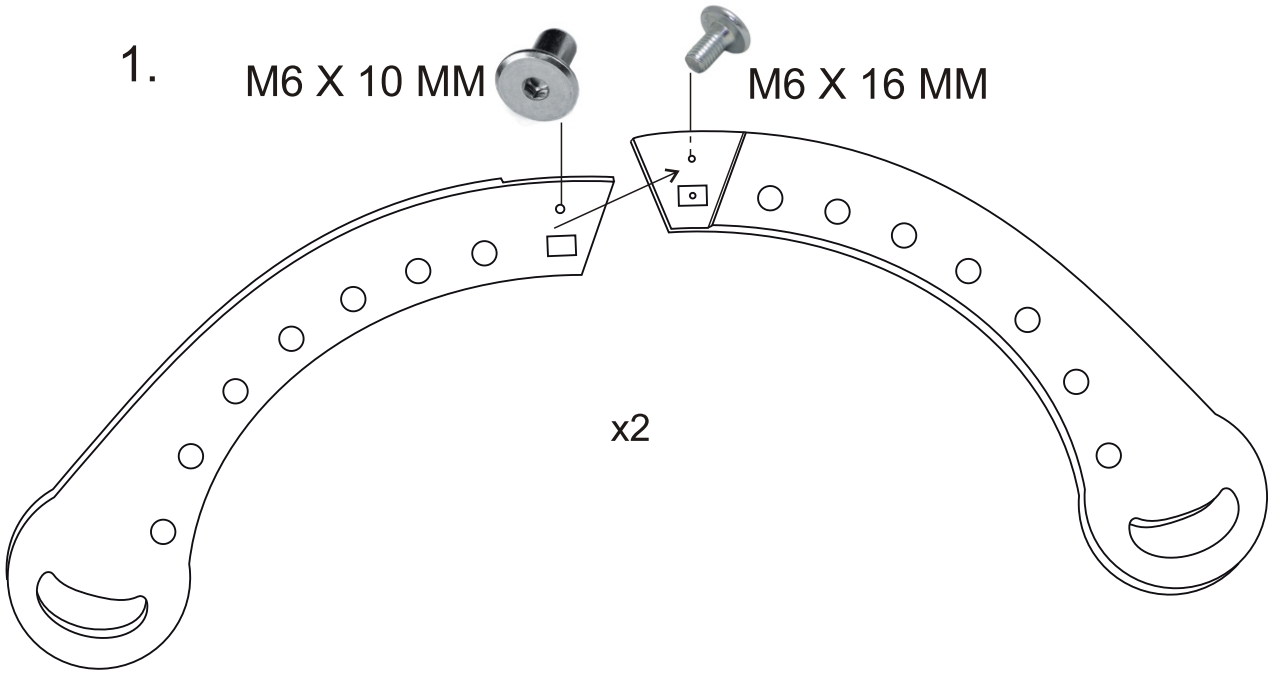

x2

2.

M6 X 50

M6 x 10 x 13 MM

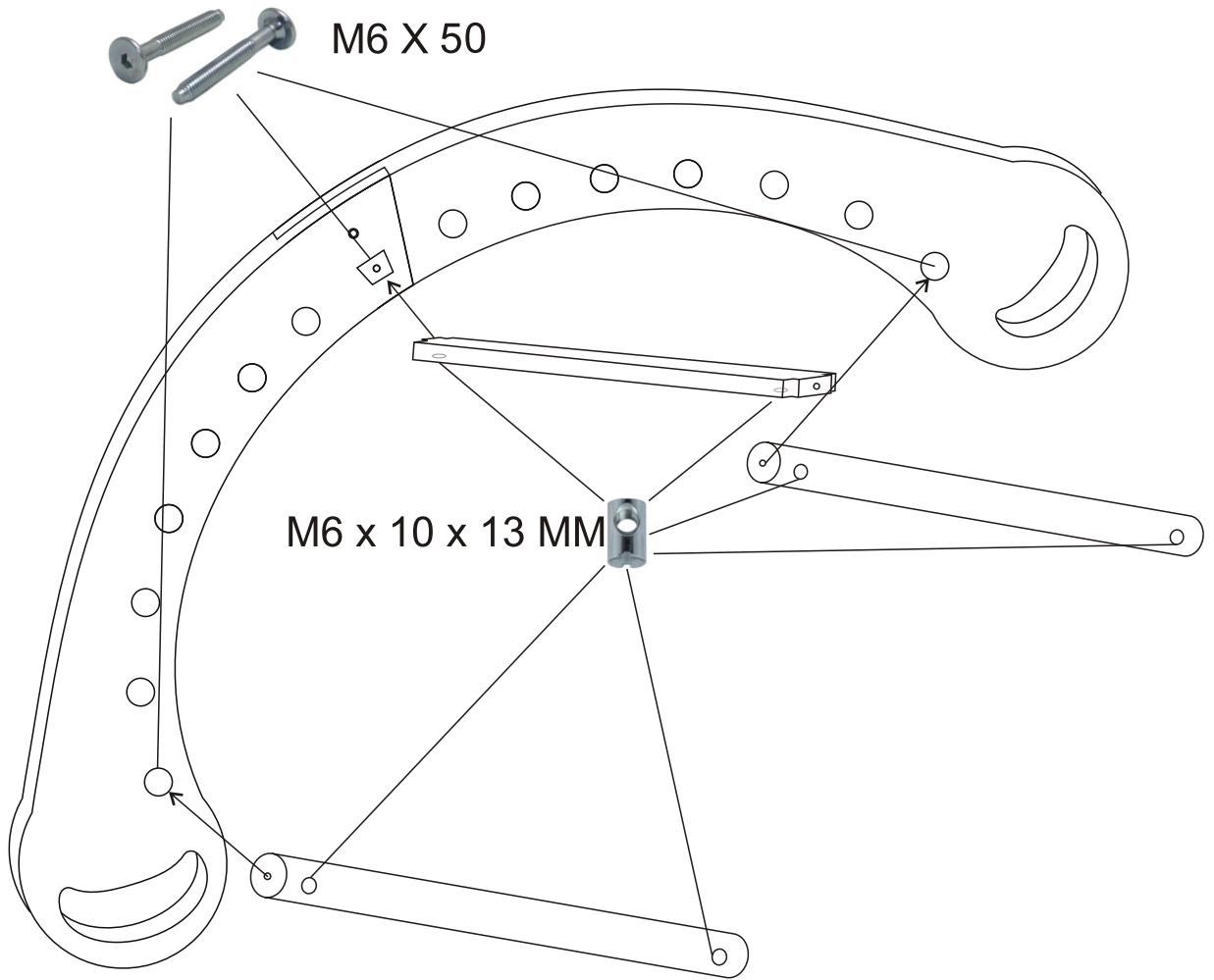

3

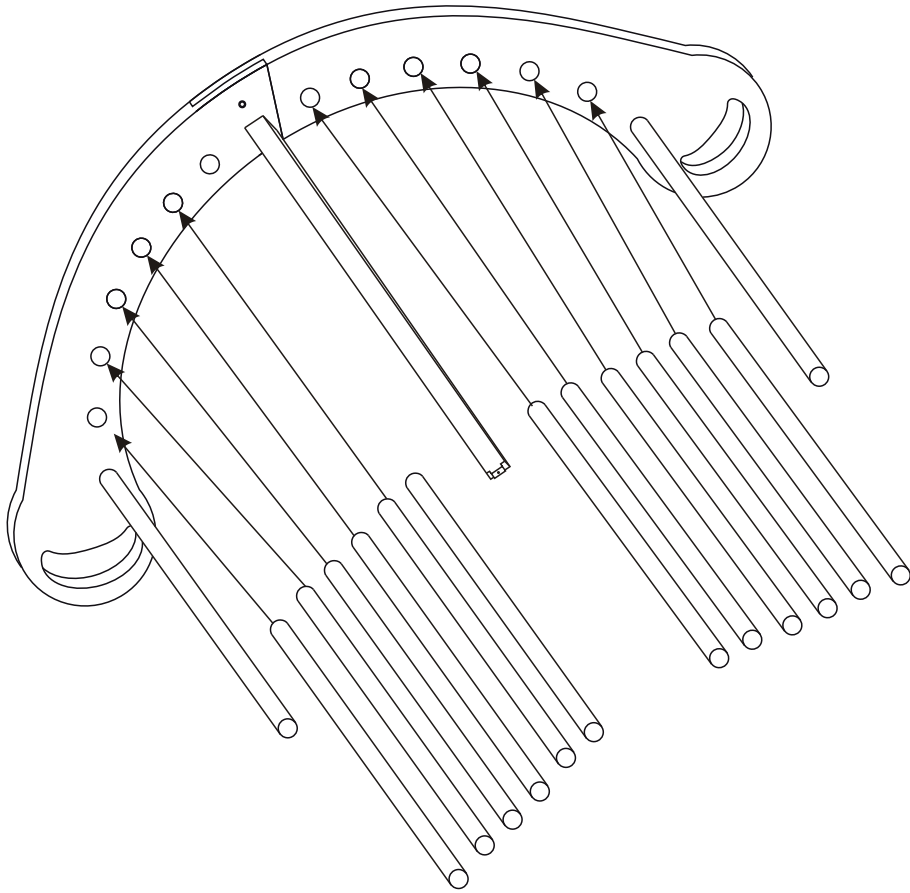

4

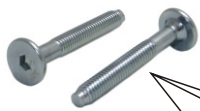

M6 X 50

